

D05H to D05HE - Valve Adapters - D05HE to D05H

VA_05H05EAB*

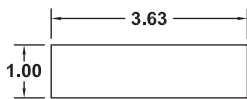
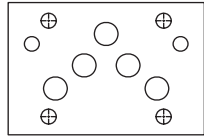

VA_05H05EAB*
S/N *****

VA_05E05HAB*

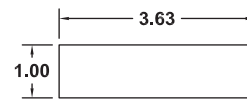
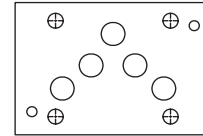

VA_05E05HAB*
S/N *****

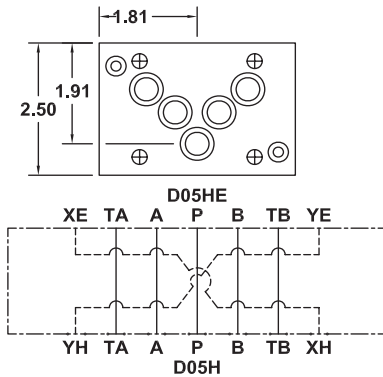

Adapter includes:
5 - 014 O-ring viton
2 - 010 O-ring viton

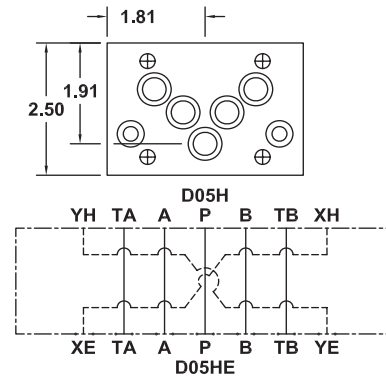

Adapter includes:
5 - 014 O-ring viton
2 - 012 O-ring viton

PART NUMBER SYSTEM

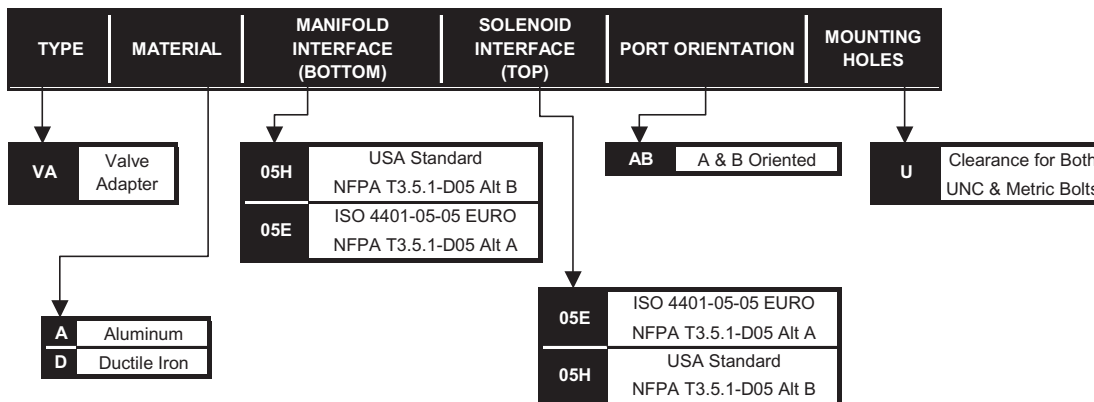

WE RESERVE THE RIGHT TO DISCONTINUE MODELS, OR CHANGE SPECIFICATIONS WITHOUT NOTICE OR INCURRING OBLIGATION

Lynch Products Can Be Modified to Suit Your Application

Phone: 1 (888) 626-4365 or +1 (905) 363-2400 Fax: 1 (800) 263-5807 www.lynch.ca sales@lynch.ca